

Bài 165: LUYỆN TẬP CHUNG

Giải Bài 165 trang 100 VBT Toán lớp 2 Tập 2

Giải câu 1. Số ?

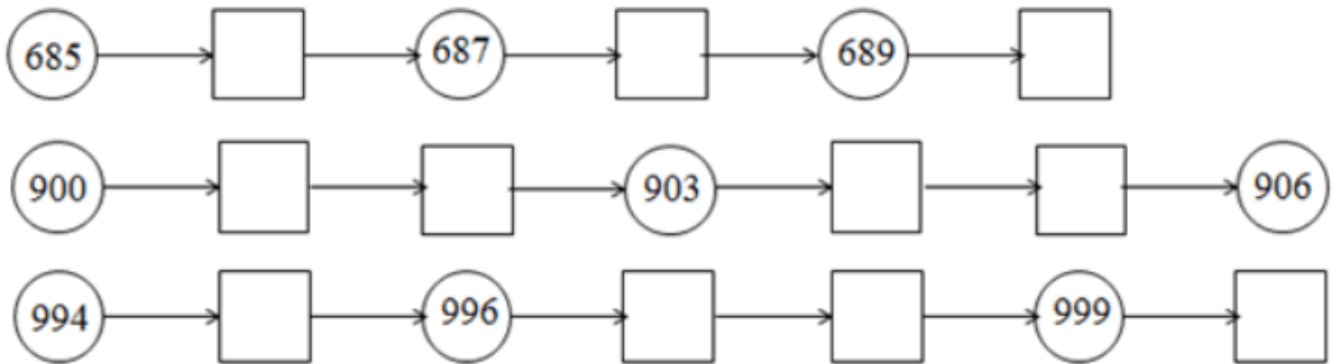

Lời giải:

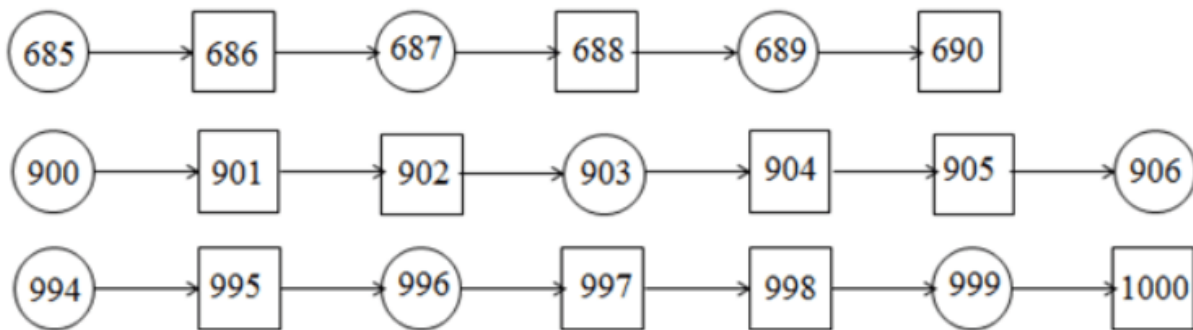

Giải câu 2. Điền >, <, =

505.....510

642.....624

736.....700 + 36

300 + 60 + 8.....386

500 + 70 + 4.....574

600 + 140 + 3.....643

Lời giải:

$$505 < 510$$

$$642 > 624$$

$$736 = 700 + 36$$

$$300 + 60 + 8 < 386$$

$$500 + 70 + 4 = 574$$

$$600 + 140 + 3 > 643$$

Giải câu 3. Số ?

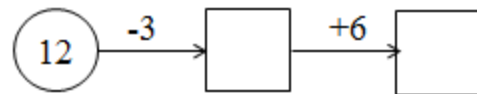
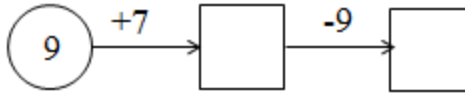
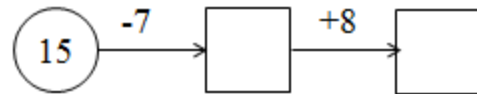
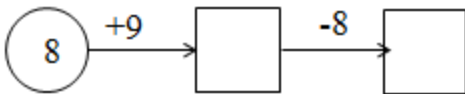

Lời giải:

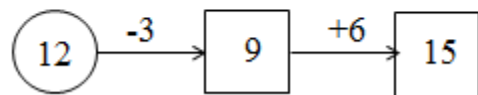
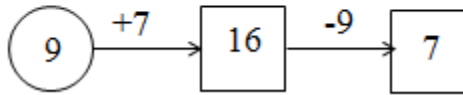
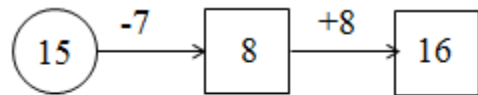
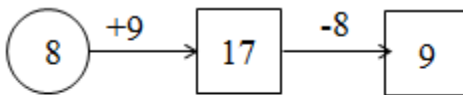

Giải câu 4. Đồng hồ chỉ mấy giờ ?



Lời giải:



5 giờ rưỡi



4 giờ 15 phút



6 giờ 15 phút

Giải câu 5. Vẽ hình (theo mẫu) :

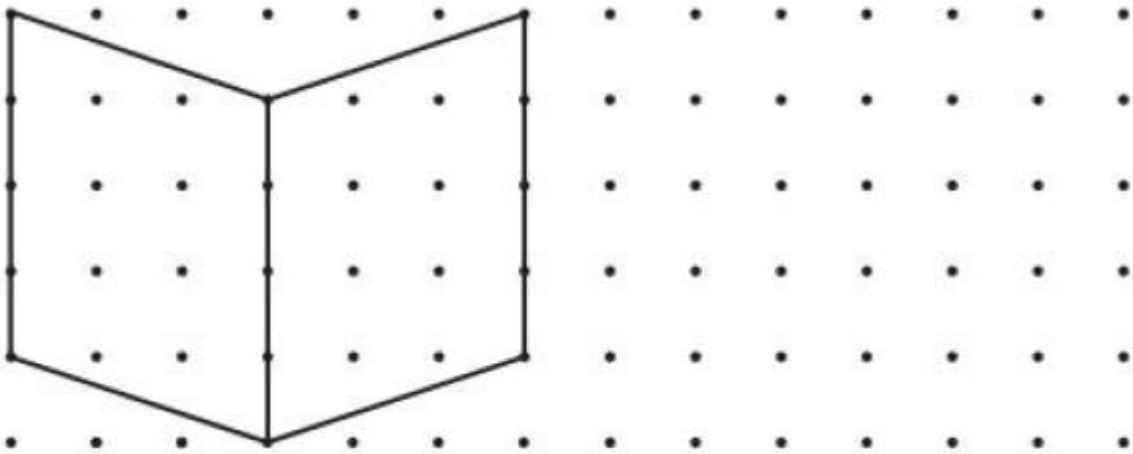

Lời giải:

Học sinh tự vẽ